



Rocking Foundations

Validation using large scale shake table testing

Tom Shantz

Caltrans Division of Research and Innovation
December 12, 2016



Project history

- Caltrans released a RFP for “innovative foundations”.
- Bruce Kutter (UCD) proposed use of “rocking foundations”.
- Several studies were performed at the UCD centrifuge.
- Numerical model and simplified design procedure developed
- Validation of numerical model and development of a full bridge design procedure

Basic concept

Single column bents:

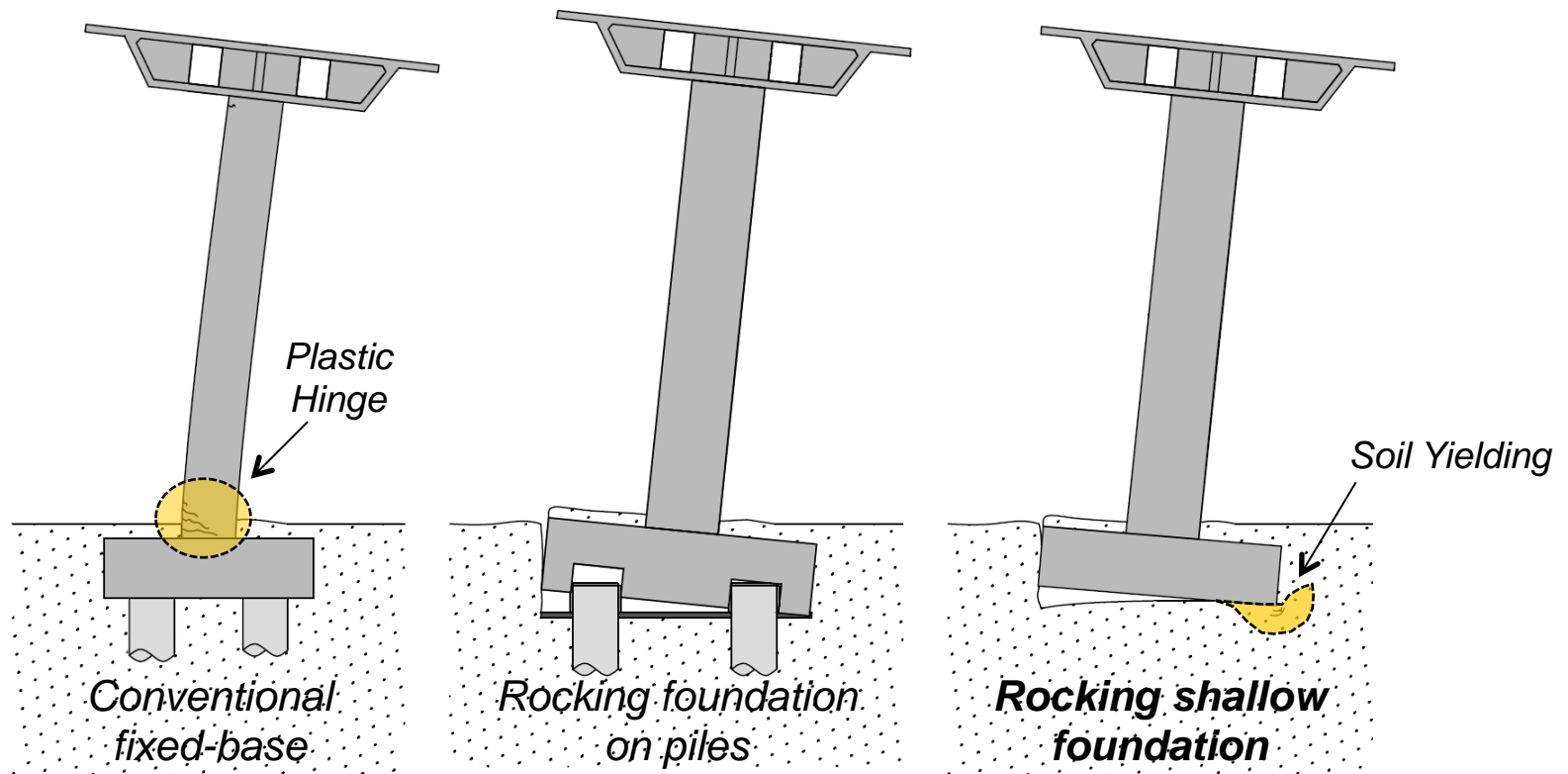

Early testing

Centrifuge testing of different H/B ratios

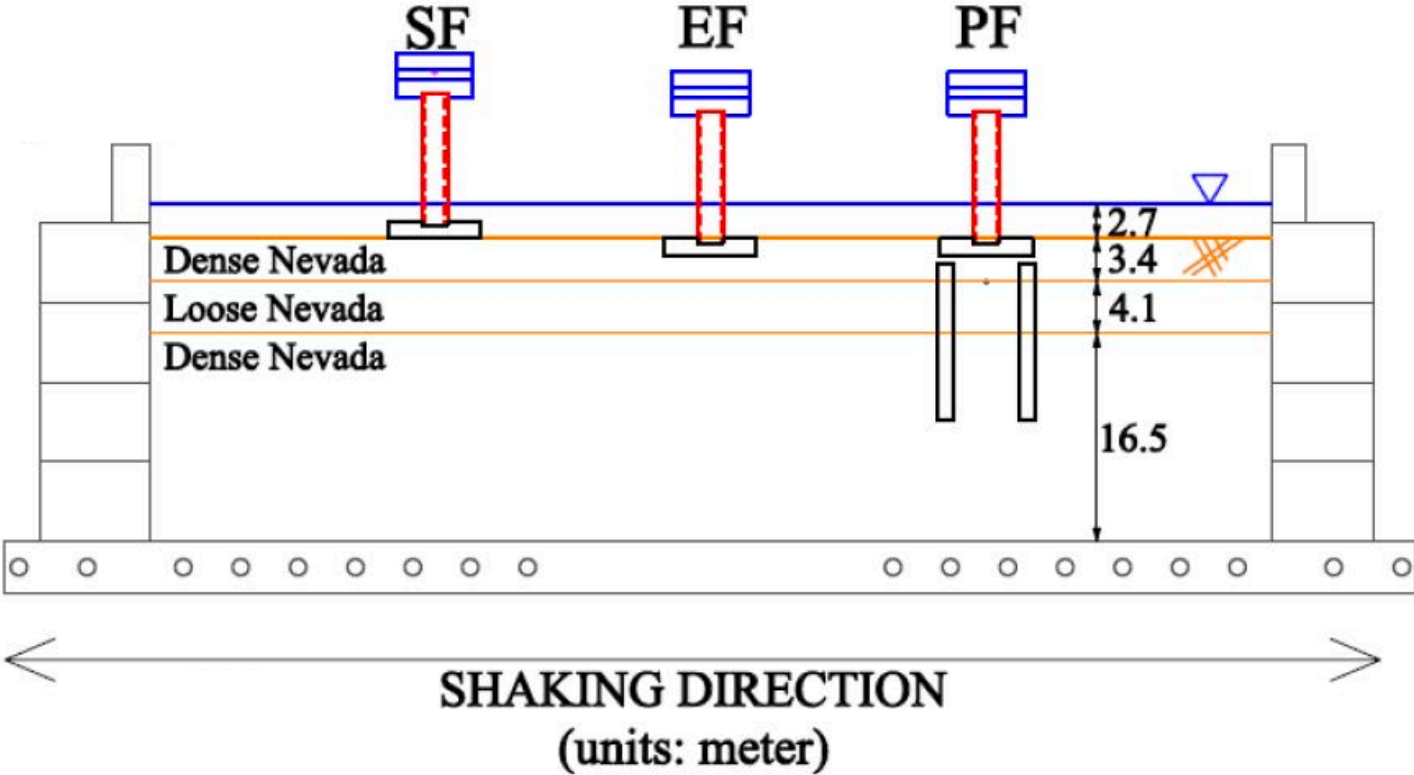

Rocking behavior

- *Typical results*

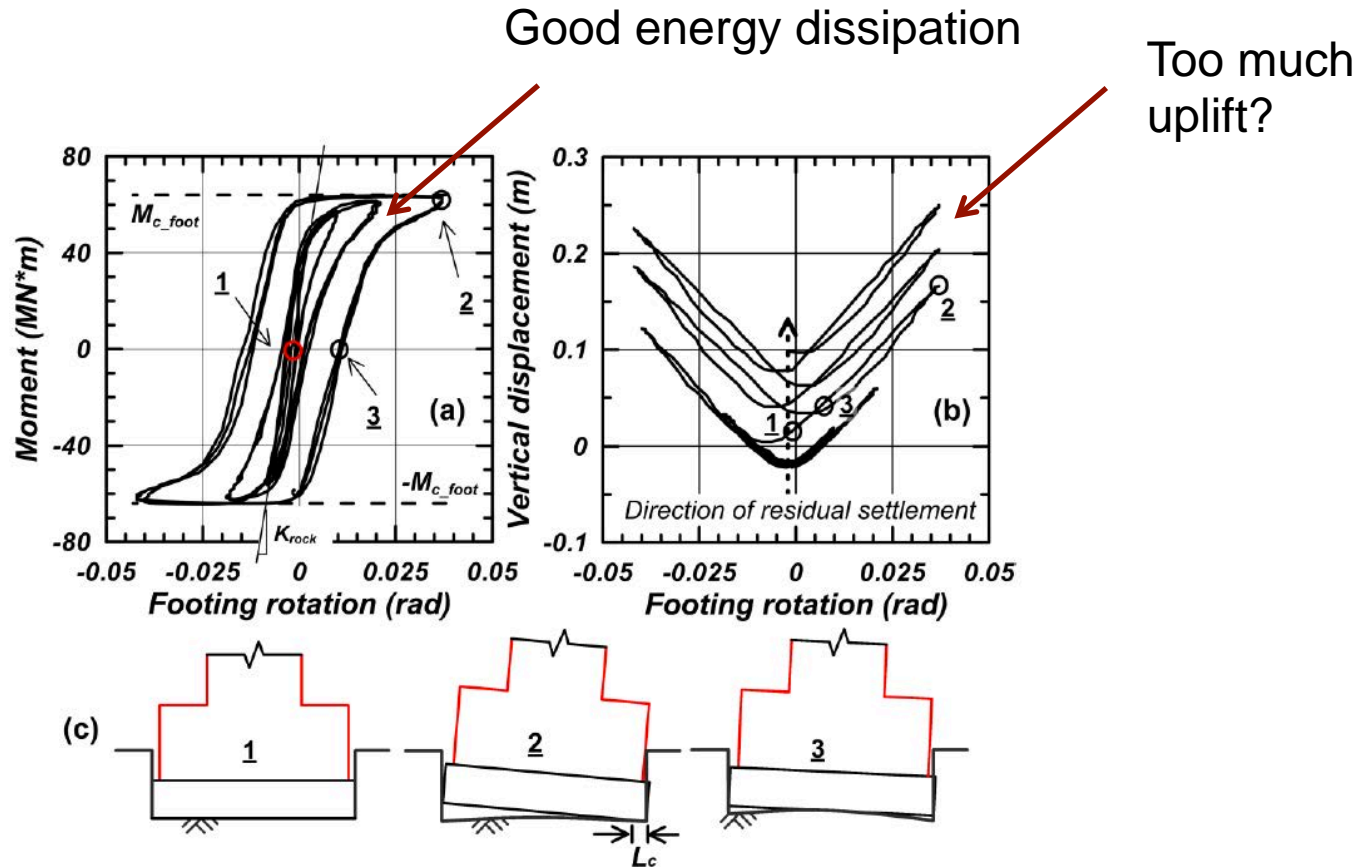

Trying to capture bridge behavior

- *Centrifuge testing of simple bridges*

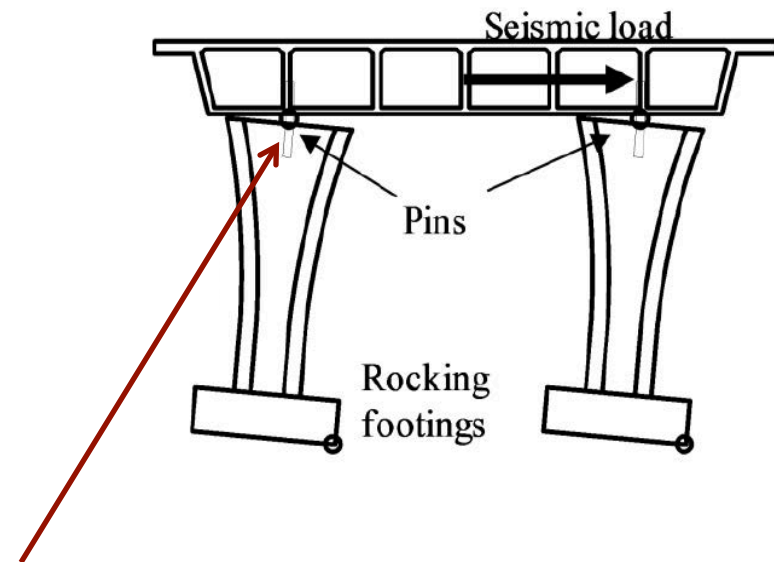
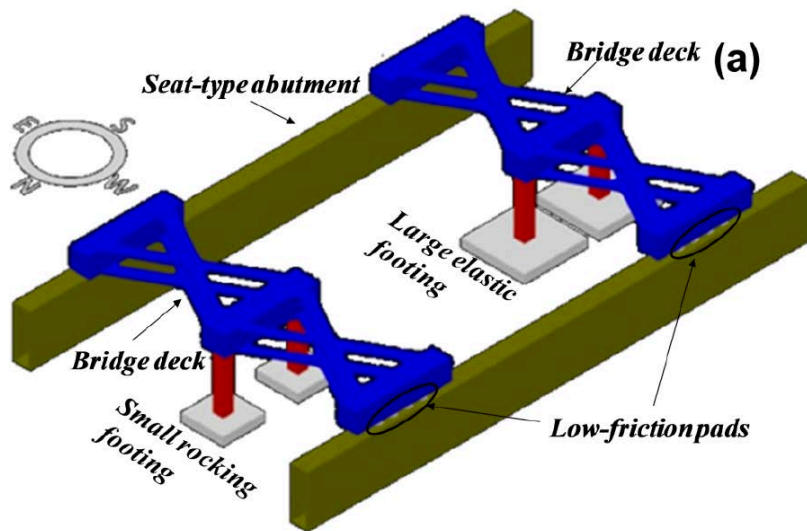

To enable rocking, the pin must be moved from the bottom of the column to the top.

Analytical models

Simple hand calcs:

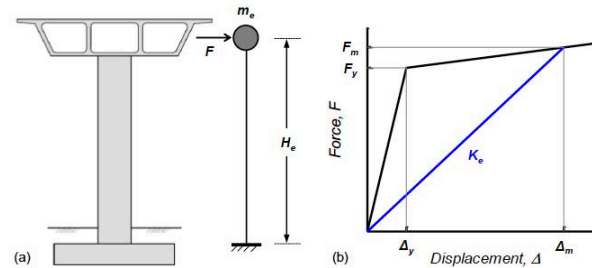

Transform into an equivalent SDF

Numerical models:

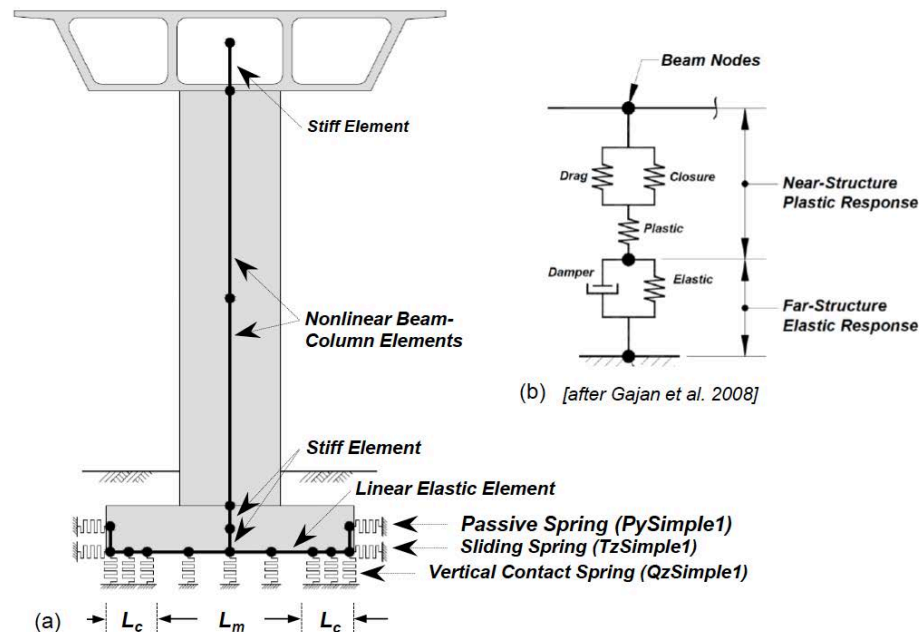

Stability evaluation

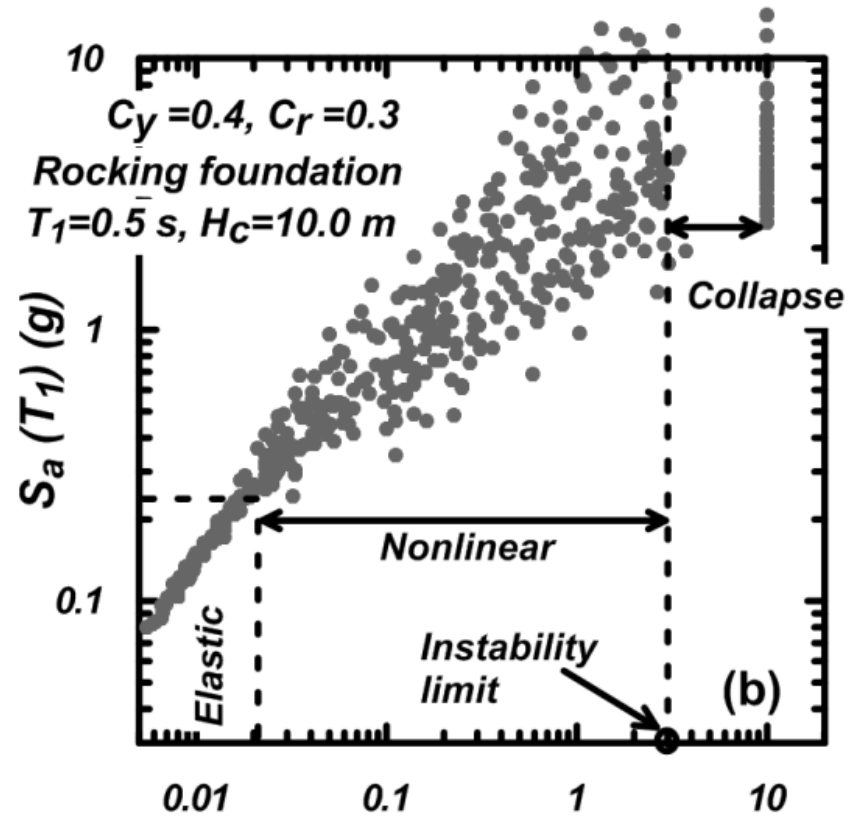
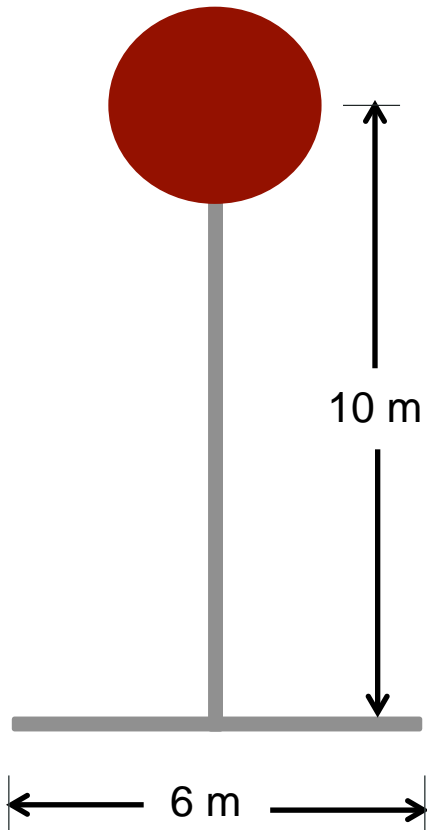

Motivation for shaketable testing

- Validate numerical model
- Investigate “off-axis” rocking
- Investigate pile-cap connection details
- Demonstrate that even under extreme shaking tip-over isn't a issue

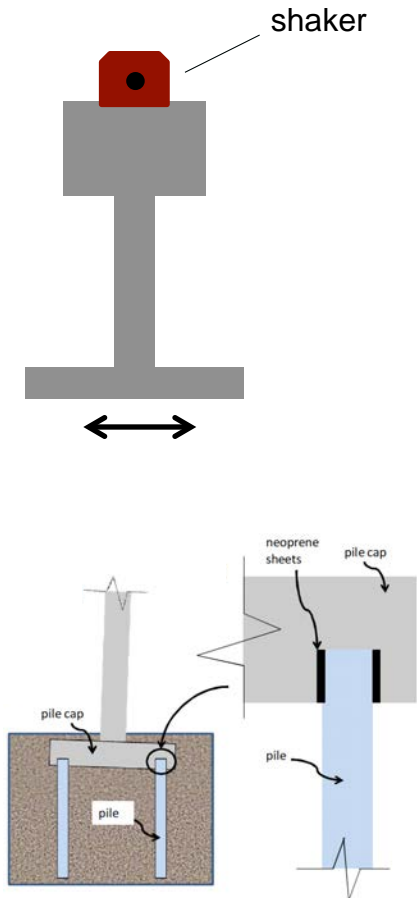

Test Layout

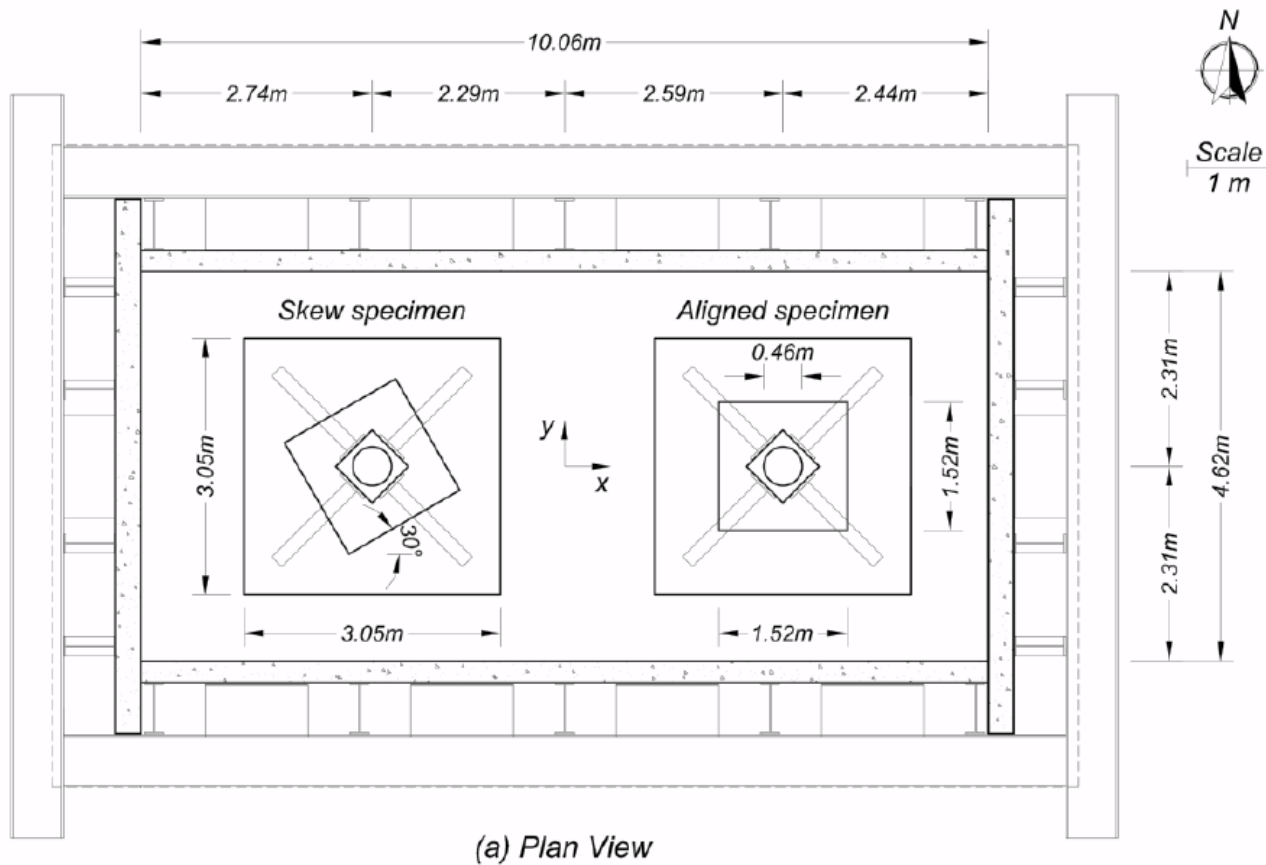

Key parameters

- $W = 290 \text{ kN}$
- $H / L = 2.0$
- $A / A_c = 13$
- $FS_v = 24$
- $C_r = 0.26$
- $C_y = 0.47$

Test layout

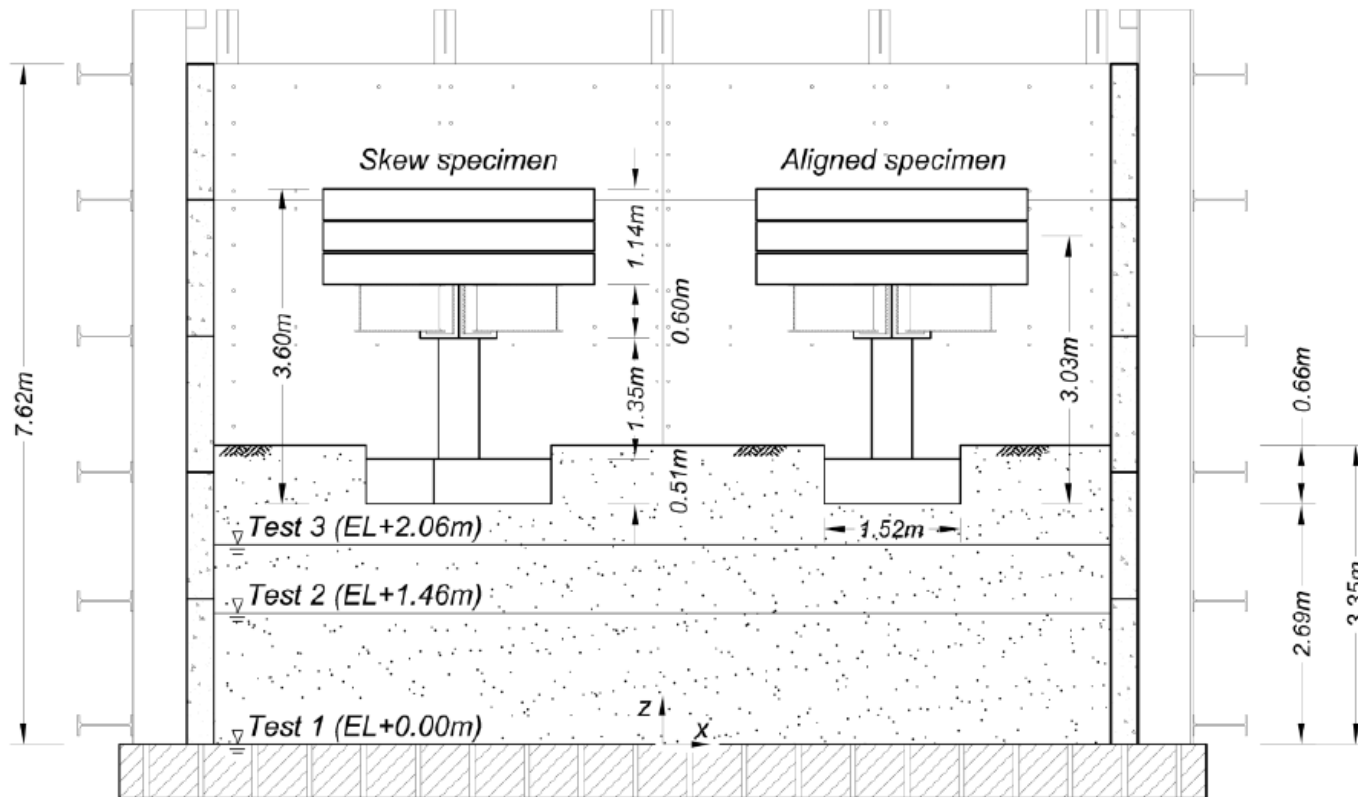

(b) South Elevation View

Test layout

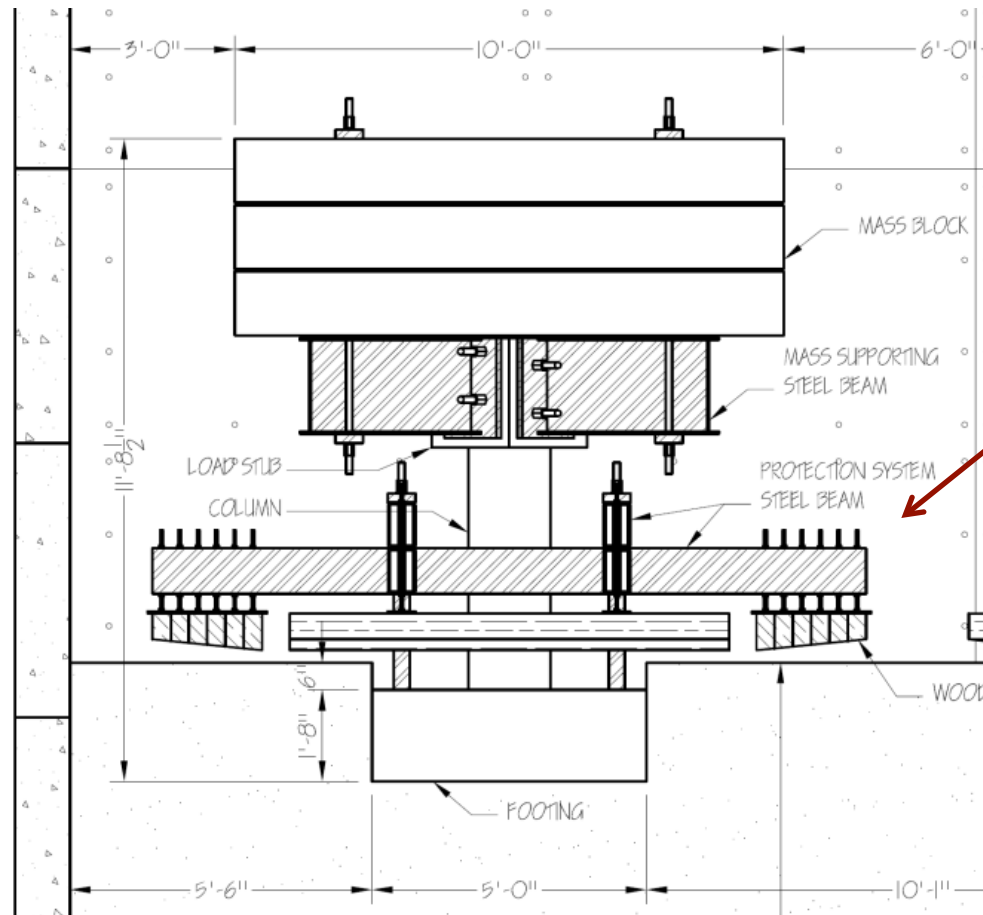

Added to limit excessive rotation

Test specimen construction



Outrigger restrainer



Test specimen construction

- *Adding the block mass*



Soil box assembly

- *Erection of vertical elements and post-tensioning to the shake table platen*



Soil box assembly

- *Placement of Concrete Panels*



Soil box assembly

- *Completed soil box*

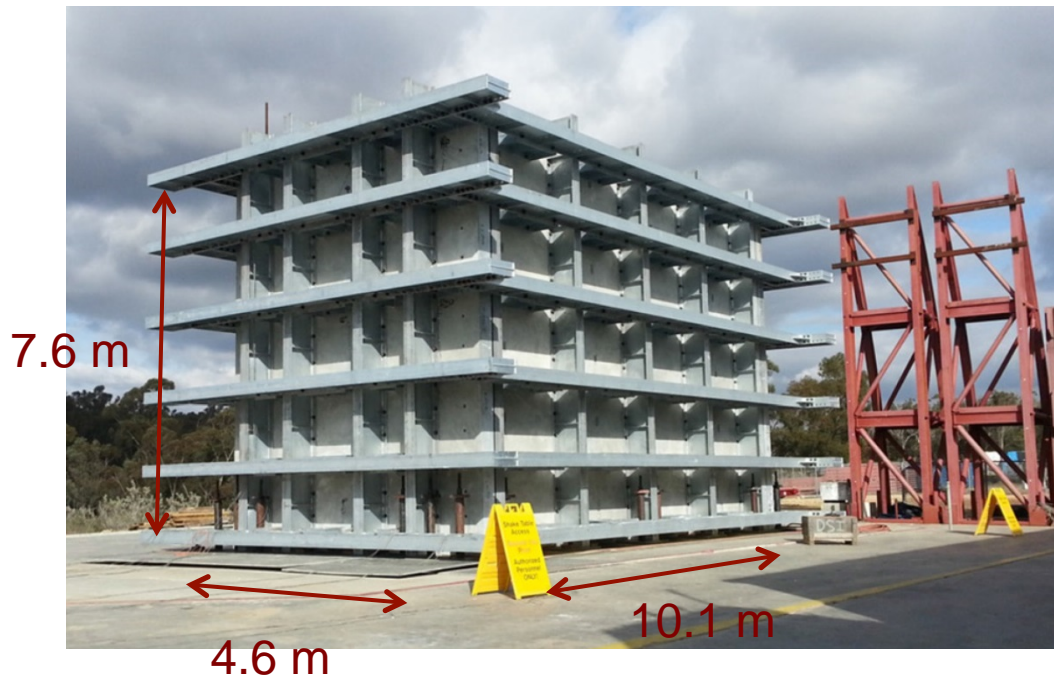

Interior box dimensions



Soil box assembly

- Soil box interior

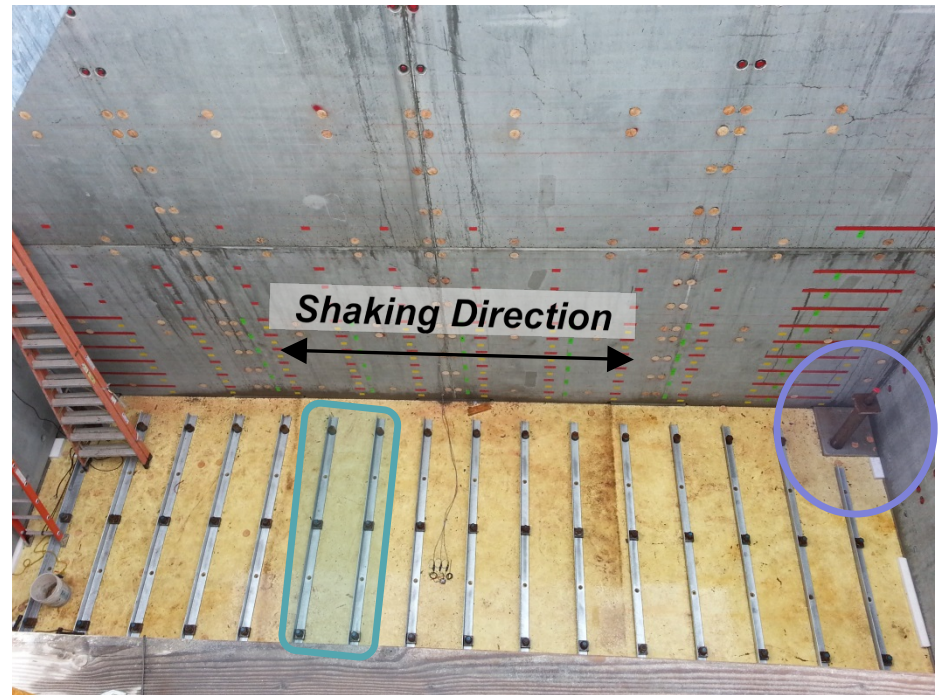

16 steel angles bolt to the platen to provide no-slip condition at the bottom boundary

4 PT rods running through the parts of corner column base plates sticking into the box

Filling and removal



Conveyor belt method
(slow and cheap)



Hopper and crane method
(fast and expensive)

Membrane placement

- *A geotextile was placed first to protect the liner*



Membrane placement

- Placement and patching

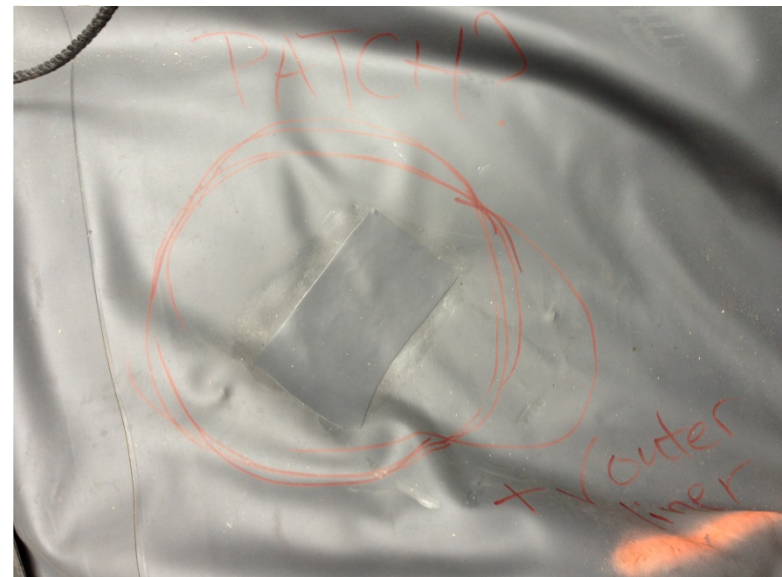

Soil placement

- *Saturation and dewatering system*



Soil placement

➤ Soil Compaction

- *Loose lifts of 200 mm thick compacted at a water content of 6% down to about 150 mm*
- *Walk-behind vibratory plate with 8 passes per lift*
 - ✓ *First 4 lifts after placement of liner and saturation/dewatering system*
 - ✓ *Lifts above the footings' base elevation*
 - ✓ *Near box walls (in general)*
- *Skid-steer loader with an attached vibratory roller (1.22 m wide, 7.95 kN heavy vibrating at 40 Hz) with 6 passes per lift*



Instrumentation

- *Soil accelerometers placement*



Marking of locations before placement



Placement of accelerometers



Covering with soil and cables running

Instrumentation

➤ Pore Pressure Transducers (PPT) Placement

- Challenging to prevent desaturation of sensors during the 2-3 weeks period for which they remained above water table

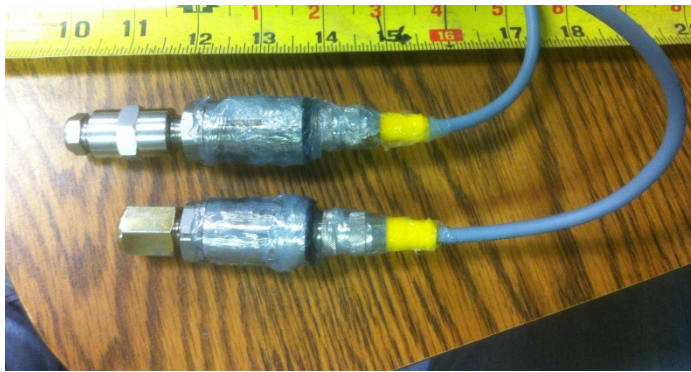

Specimen placement



Instrumentation

➤ Structures' Instrumentation

- *Mass Blocks' String Potentiometers*
 - ✓ *6 linearly independent String Pots (3 horizontal + 3 vertical) to determine 6 DoFs*

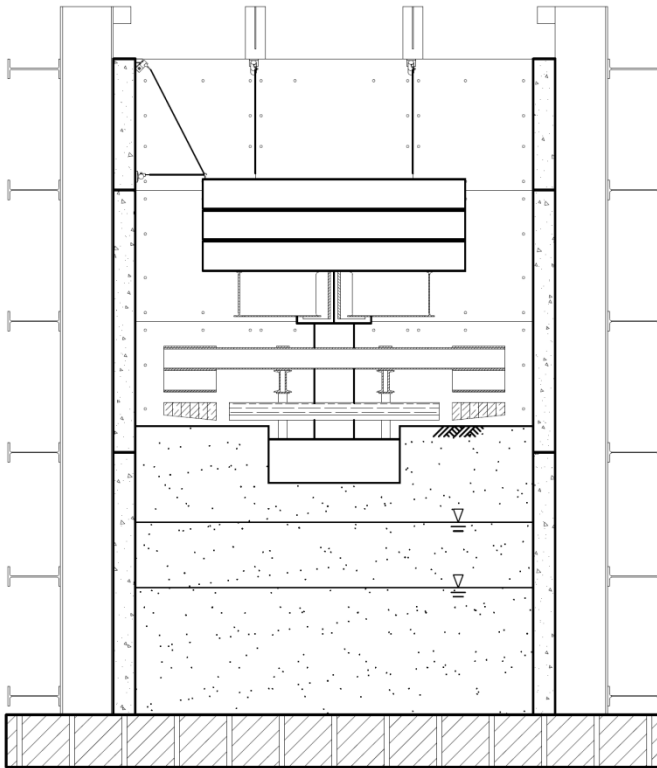

Instrumentation

➤ **Video Cameras Used**

- *Coaxial cameras [8]*
 - ✓ *Wired, power-supported, low resolution (768 × 494 pixels at 30 fps)*
 - ✓ *Live video streaming; can be played back during testing*
 - ✓ *168 out of 168 events successfully recorded*
- *GoPro2 cameras [11]*
 - ✓ *Wireless, battery-supported, high resolution (1920 × 1080 pixels at 30 fps)*
 - ✓ *Can be accessed and played back after testing*
 - ✓ *126 out of 231 events successfully recorded*
- *Sony cameras [2]*
 - ✓ *Man-operated, battery-supported, high resolution (1920 × 1080 pixels at 30 fps)*
 - ✓ *Can be accessed and played back after testing*
 - ✓ *29 out of 42 events successfully recorded*

Loading input

Test protocol and linear spectra (1% damping)

	Motion	Scale factor
1	Gilroy Array 1	1.0
2	Corralitos	0.8
3	El Centro Array 6	1.1
4	Pacoima Dam	0.8
5	Takatori	0.5
6	Takatori	1.0
7*	Parachute Site	1.0
8*	Parachute Site	-1.0
9*	Parachute Site	1.1

*Only for test day 3

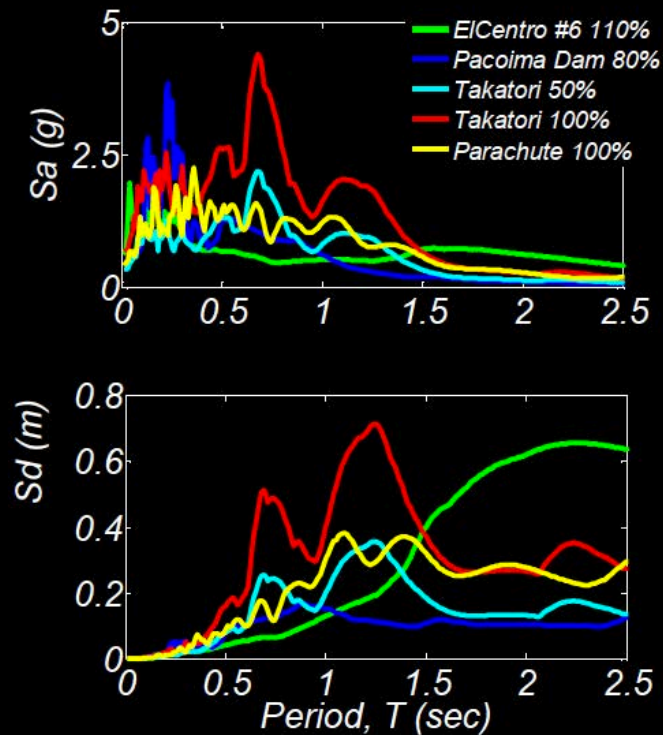

For all motions the time was compressed by 1.73

8

Video...

Large-scale shake table test of
columns supported on
rocking shallow foundations



NEES @ UCSD



Test Response

➤ Column Drift Ratio Time Histories for Test Days 1 and 2

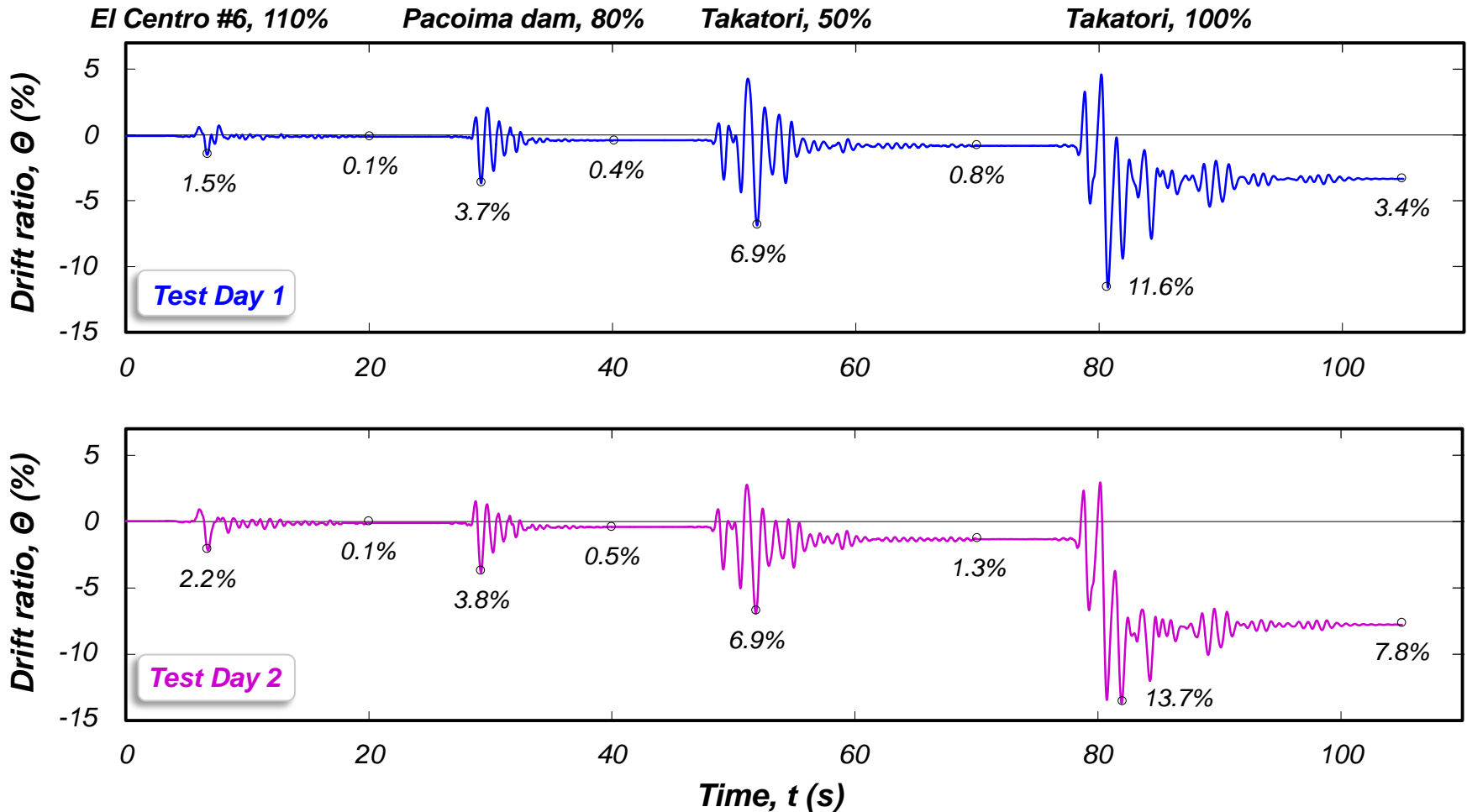

Concluding Remarks

- *The road from initial concept to deployment is a long one...*
 - *Positives: Better performance for less \$. The shaketable testing provided a clear illustration of excellent performance under extreme loading.*
 - *Negatives: Requires a substantial change in design philosophy*
- *Need to work on pile-footing connection details to expand application to pile supported foundations*
- *Soil box assembly and disassembly is expensive*

Acknowledgements

- *Principal investigators*
 - *Marios Panagiotou (formerly UCB)*
 - *Bruce Kutter (UCD)*
 - *Patrick J. Fox (formerly UCSD)*
 - *Jose I. Restrepo (UCSD)*
- *Student researchers*
 - *Grigorios Antonellis (formerly UCB)*
 - *Gabriele Guerrini (formerly UCSD)*
 - *Andrew Sander (UCSD)*
 - *Lijun Deng (UCD) – previous centrifuge work*
- *Technical staff at NEES @ UC San Diego*
 - *Dan Radulescu*
 - *Paul Greco*
 - *Alex Sherman*
 - *Hector Vicencio*
 - *Raymond Hughey*
 - *Robert Beckley*
 - *Lawton Rodriguez*

